



コードパーツ関連



コードロック	27
ブタ鼻	40
コードエンド	42
コードパーツ	52
サスペンダー	54



new AST 1021
AG, BN, N
MB(S)/MC(D)



new AST 1022
AG, BN, N
MB(S)/MC(D)



new AST 1023
AG, BN, N
MB(S)/MC(D)



new CS 3057N
G, N, PG, PN, BN, AG
ABS/SUS



CS 3050Nの使用事例



これまでのストッパーの形状にテープ差し部を設けました。ストッパーがアウターにフィットし、アクティブな場面でも邪魔になりません。



new CS 3058N
G, N, BN, AG
ABS/SUS



new CS 3050N
G, N, BN, AG
ABS/SUS



AXP 5631
PN
ABS/SUS



new KP 9421N
9
G, N, BN, AG
ABS



KP 9368N
G, N, BN, AG
ABS



AKP 8560N
G, N, BN, AG
ABS



KP 9354N
G, N, PN, BN
ABS



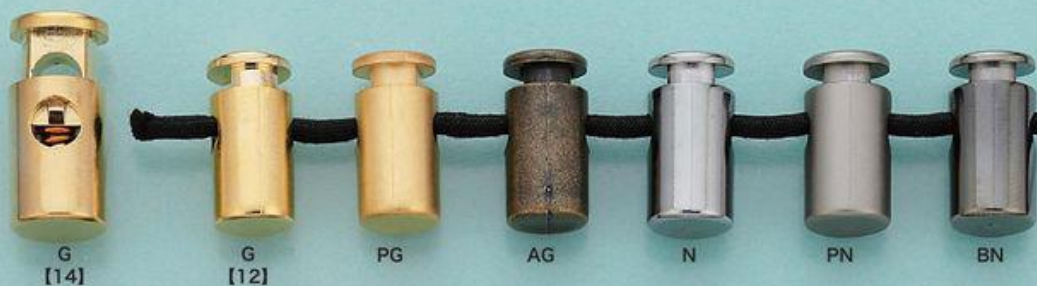

G [14] G [12] PG AG N PN BN

028



PS DS BAG

BP 5564
9
PS,DS,BAG
PA/SUS
◇ ⊗

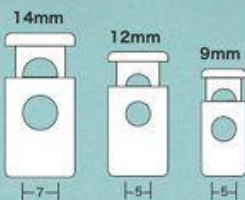

BP 5564
14,12
G,PG,AG,N,PN,BN
ABS/SUS
◇



G [14] G [12] PG AG N PN BN

BP 5907
14,12
G,N,PG,PN,AG,BN
ABS/SUS
◇

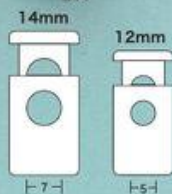

●コード (形状・太さ) サンプル



先染めポリエステル
エラストックブレード
K-610

ポリエステル 45% ラバー 55% (50m カセ)

●カラーサンプルよりお選びください。

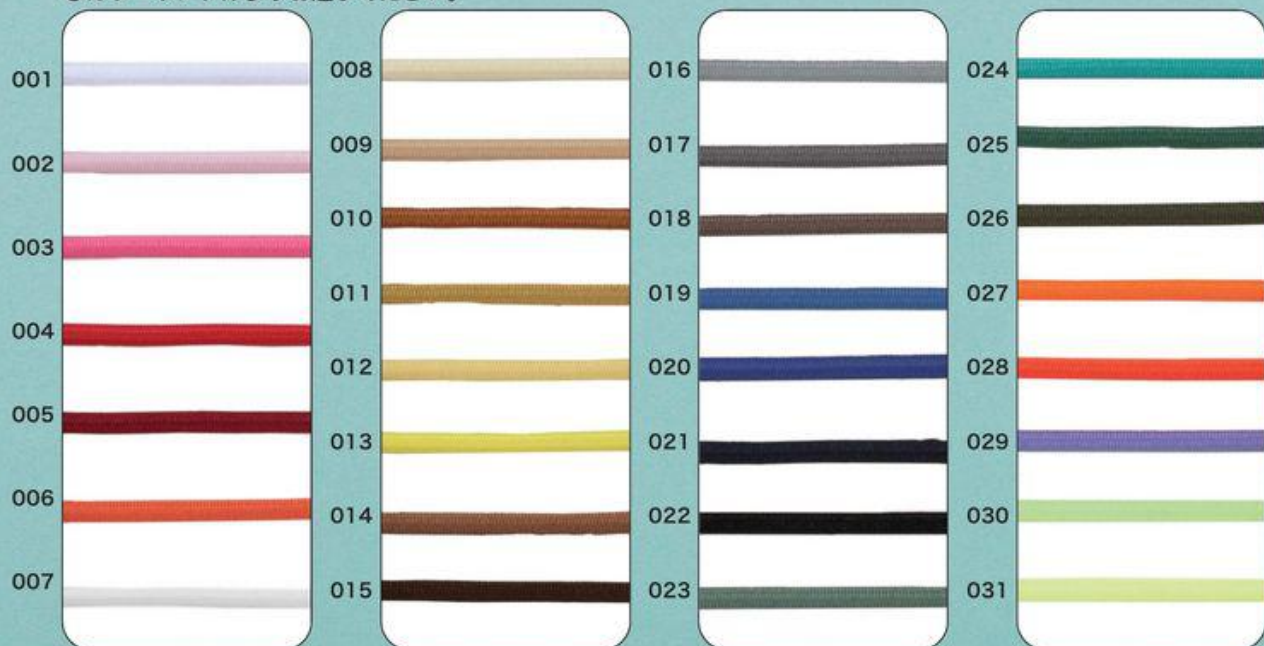

コードの取扱い

※コードの取扱いの詳細、試験データは、[素材の取扱い上のご注意] をご覧下さい。

※ドライクリーニングの際、パークロエチレンは使用不可。 ※サンプル (見本) ご依頼は、長さ (1m ~ 5m) の範囲で承ります。他、ご不明な点は当社営業員にお問い合わせください。



AB 7601N
 G,N,BN,PN,AG
 MCD/SUS



CS 3031N
 G,N,PN,BN,AG
 ABS/SUS



new CS 3051N
 G,N,BN,AG
 ABS/SUS



AXP 5629
 ASI,AG
 MCD/MB





AST 1016
 N,ASI,BN,ABN,AG
 ABS/MB





BP 6103
 PS,DS
 PA/SUS



new CS 3059N
 G,N,BN,AG
 ABS/SUS



AST 1003
 AG
 ABS/MB

AST 1004
 AG
 ABS/MB



上面画像



G N BN

new CS 3043N
 -
 G,N,BN
 RH/ABS/SUS
 3.5



G AG

CS 2202N
 -
 G,AG
 ABS/SUS
 5 | 5



G N PG PN BN AG

CS 3040N
 -
 G,N,PG,PN,BN,AG
 ABS/SUS
 4.0



PS DS BAG

BP 6109
 9
 PS,DS,BAG
 PA/SUS
 4



G N ASI BN ABN AG

AST 1017
 -
 G,N,ASI,BN,ABN,AG
 ABS/MB
 4.0



AXP 5630
 -
 PN
 ABS/SUS
 2.3



G N BN AG

new CS 3060N
 -
 G,N,BN,AG
 ABS/SUS
 5



N ASI BN ABN AG

new AST 1020
 -
 N,ASI,BN,ABN,AG
 ABS/MB
 3.0



new **AST 1024**
 N, BN, AG
 ABS/MB

new **CS 3048N**
 G, N, BN, AG
 ABS/SUS



new **CS 3049N**
 G, N, BN, AG
 ABS/SUS

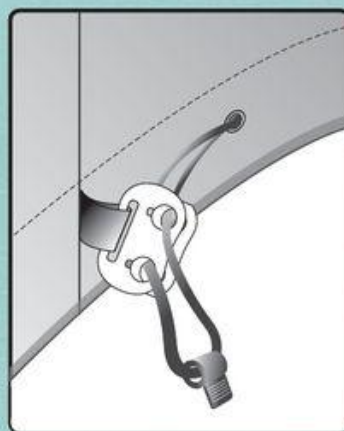

CS 3049N使用イメージ



BP 5088
 G, N, PG, PN, AG, BN
 ABS/SUS



AST 1001
 AG
 ABS/MB

AST 1002
 AG, PN
 ABS/MB

CS 2201N
 G, AG, BN
 ABS/MB



2 6

NEW **OW 5800**

8
2.6

WO(P)/SUS

✦ ✧ ✨ ✨ ✨ ✨ ✨ ✨ ✨ ✨

廃番
Discontinued



NEW **CS 6323**

-
N
PP

✦ ✧ ✨ ✨ ✨ ✨ ✨ ✨ ✨ ✨



00

NEW **CS 3043N**

-
00 G,N,BN
RH/PC/SUS RH/ABS/SUS

✦ ✧ ✨ ✨ ✨ ✨ ✨ ✨ ✨ ✨



〈染色イメージ〉



CS 3033N

-
A01,B01,G01,N01
PA/ABS/SUS

✦ ✧ ✨ ✨ ✨ ✨ ✨ ✨ ✨ ✨



※バラ納品になります。

〈染色イメージ〉



CS 3032N

-
A01,B01,G01,N01
PA/MC@/SUS

✦ ✧ ✨ ✨ ✨ ✨ ✨ ✨ ✨ ✨



※バラ納品になります。

〈染色イメージ〉



CS 3034N

-
A01,B01,G01,N01
PA/ABS/SUS

✦ ✧ ✨ ✨ ✨ ✨ ✨ ✨ ✨ ✨



※バラ納品になります。



new AXP 5722
 -
 09
 PA
 * 穴径: 4mm

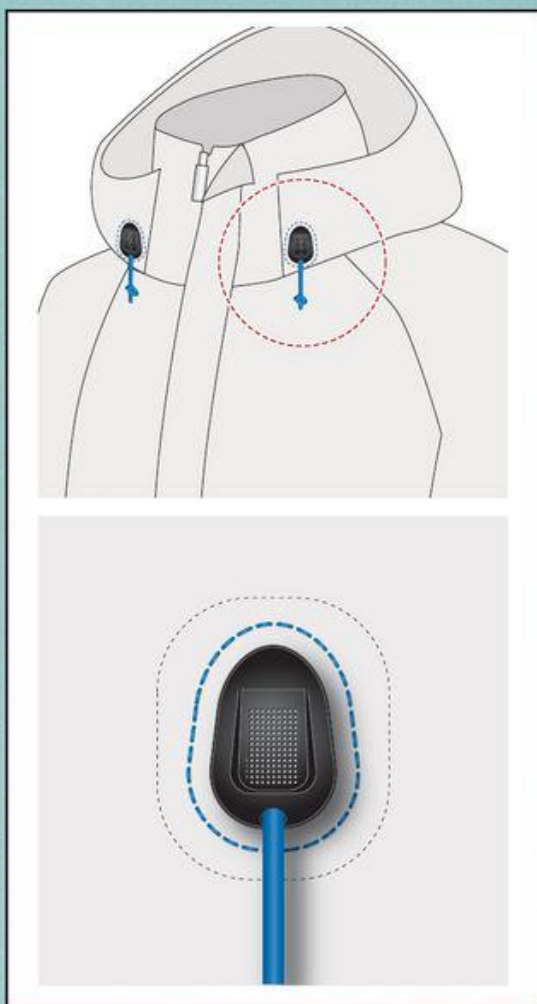

AXP 5722使用イメージ



AG



BN





ABN



09

AST 1019

-
 09 BN,ABN,AG
 PA/MB ABS/MB
 *  

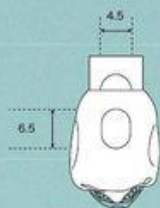



00 01 09

CS 3019

00	01,09
PC/SUS	PA/SUS

☀️ ⚡️ 🔒 🔓 🔗

※00,01 はバラ納品になります。



01 09

CS 3052N

01,09
PA/SUS

☀️ ⚡️ 🔒

※01 はバラ納品になります。



00

CS 3051N

9
00
PC/SUS

☀️ ⚡️ 🔒 🔓



01 09

CS 2226N

01,09
PA/MB

☀️ ⚡️ 🔒

※01 はバラ納品になります。



00 01 09

BP 6103

00	01,09
PC/SUS	PA/SUS

☀️ ⚡️ 🔒 🔓 🔗

※00,01 はバラ納品になります。

〈染色イメージ〉



01 [14] 01 [12] 00 [9] 01 08 09

BP 5564

14,12,9
00 01,08,09
PC/SUS PA/SUS

☀️ ⚡️ 🔒 🔓 🔗

※00,01 はバラ納品になります。
 ※00,08 は9mmのみ取り扱っております。
 ※08,09 は染色不可



01

AST 1004

01
PA/MB

☀️ ⚡️ 🔒

※バラ納品になります。



00 001 01

AST 1003

00 001,01
PC/MB PA/MB

☀️ ⚡️ 🔒 🔓 🔗

※01 はバラ納品になります。



00 [14] 白 [14] 白 [12]

BP 5907

14,12
00 白
PC/SUS PA/SUS

☀️ ⚡️ 🔒 🔓 🔗

※バラ納品になります。

〈染色イメージ〉



009

019

NEW

CS 3055N

009	019
PC/PU/SUS	PA/PU/SUS



※019 はバラ納品になります。



00

01

09

NEW

AST 1020

00	01,09
PC/SUS	PA/MB



※01 はバラ納品になります。



01

09

NEW

CS 3053N

01,09
PA/SUS

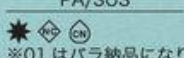

※01 はバラ納品になります。



00

01

08

09

BP 6109

9

00	01,08,09
PC/SUS	PA/SUS



※00,01 はバラ納品になります。



00

01

09

BP 6176

00	01,09
PC/SUS	PA/SUS



※00,01 はバラ納品になります。



00K

01K

09K

AKP 8515

00K	01K,09K
PC	PA

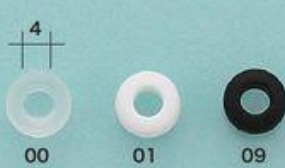

00

01

09

BP 6112

00,01,09
PA

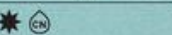

00

01

09

AST 1015

00	01,09
PC/MB	PA/MB

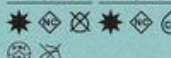

※00,01 はバラ納品になります。



00

[13]

[10]

白

09

[10]

BP 5522

15,13,10

00	白,09
PC	PA



01

47

08

AST 1018

01,08,09,47
PA/SUS

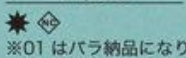

※01 はバラ納品になります。



09



00



01



09

CS 3014

00	01,09
PC/SUS	PA/SUS

※ 意匠登録 [1097844]

※00,01 はバラ納品になります。



00



01



09

CS 3024

00	01,09
PC/SUS	PA/SUS

※ 意匠登録 [1115167]

※00,01 はバラ納品になります。



00



01



09

BP 6161

00	01,09
PC/SUS	PA/SUS

※ 意匠登録 [1115166]

※00,01 はバラ納品になります。



00



01



09

CS 3030

00	01,09
PC/SUS	PA/SUS

※ 意匠登録 [1115167]

※00,01 はバラ納品になります。



00



01



09

BP 6193 (PAT.P)

00	01,09
PC/SUS	PA/SUS

※ 意匠登録 [1115166]

※00,01 はバラ納品になります。



00



01



09

CS 3026 (PAT)

00	01,09
PC/SUS	PA/SUS

※ 意匠登録 [1115167]

※00,01 はバラ納品になります。



00



01



09

BP 6192 (PAT)

00	01,09
PC/SUS	PA/SUS

※ 意匠登録 [1115166]

※00,01 はバラ納品になります。



00



01



09

CS 3025 (PAT)

00	01,09
PC/SUS	PA/SUS

※ 意匠登録 [1115167]

※00,01 はバラ納品になります。





CS 3016

00	01,09
PC/SUS	PA/SUS
☀	☀
⊗	⊗
⊗	⊗

※00,01 はバラ納品になります。



CS 3015

00	01,09
PC/SUS	PA/SUS
☀	☀
⊗	⊗
⊗	⊗

※00,01 はバラ納品になります。



BP 5088

白,48,09
PA/SUS
☀
⊗
⊗

※白はバラ納品になります。
※48,09 は染色不可



CS 2201N

01
PA/MB
☀
⊗
⊗

※バラ納品になります。



CS 2202N

01
PA/MB
☀
⊗
⊗

※バラ納品になります。

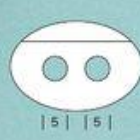

AST 1001

00	01,09
PC/MB	PA/MB
☀	☀
⊗	⊗
⊗	⊗

※01 はバラ納品になります。

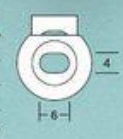

AST 1002

00	01,09
PC/MB	PA/MB
☀	☀
⊗	⊗
⊗	⊗

※01 はバラ納品になります。



MK-525 ミックスブレード

ポリエステル 100% (一反 50m 巻)

●コード (形状・太さ) サンプル

S30
(太さ見本)

L50
(太さ見本)



●コードカラーサンプル

(カラーNo.)

M25

M26

M27

M28

M29

M30



M31

M32

M33

M34

M35

M36



M37

M38

M39

M40

M41

M42

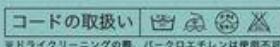

※コードの取扱いの詳細、試験データは、[素材の取扱い上のご注意] をご覧下さい。

※ドライトリミングの際、パークロエチレンは使用不可。 ※サンプル (見本) の依頼は、長さ (1m ~ 10m) の範囲で承ります。他、ご不明な点は当社営業員にお問い合わせください。

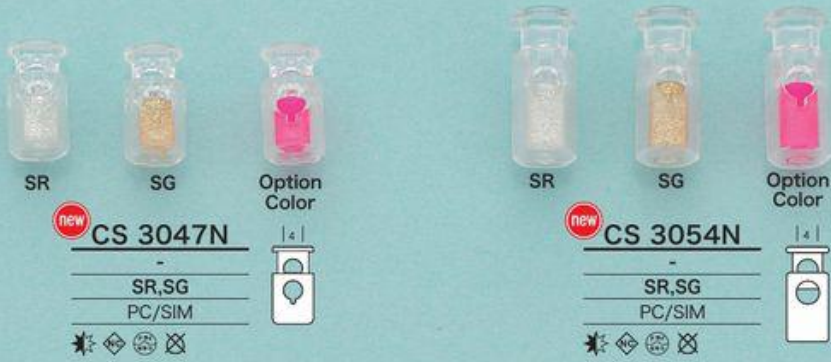

NEW CS 3047N
-
SR,SG
PC/SIM
☀️ Ⓜ️ ⚙️ ❌

NEW CS 3054N
-
SR,SG
PC/SIM
☀️ Ⓜ️ ⚙️ ❌



NEW CS 3056N
-
G00,N00,B00,W00
PA/PC/SUS
☀️ Ⓜ️ ⚙️ ❌



CS 3036
-
01 00,013,015
09 035,058,065
PA/SIM PC/SIM
☀️ Ⓜ️ ⚙️ ❌
※00,01 はバラ納品になります。



CS 3035
-
01 00,013,015
09 035,058,065
PA/SIM PC/SIM
☀️ Ⓜ️ ⚙️ ❌
※00,01 はバラ納品になります。



41



46



49

OJM 679V

-
41,46,49
UP



* (P)

01



42



45



48



09

KP 9365

-
01 42,45,48,09
PA PA



* (P) * (X)



011



421



431



451



099

OJM 670V

-
011,099,421,431,451
UP



* (X)



011



421



431



451



099

OJM 669V

-
011,099,421,431,451
UP



* (X)



011



421



431



451



099

OJM 671V

-
011,099,421,431,451
PA/UP/SUS



* (X)

*バラ納品になります。



011



421



431



451



099

OJM 672V

-
011,099,421,431,451
PA/UP/SUS



* (X)

*バラ納品になります。



1



3



5

NEW AXP 5662 廃番 Discontinued
-
1,3,5
LE/MB
☞ ☒ 穴径：4.4mm



NEW AXP 5561 廃番 Discontinued
23
42
LE/MB
☒ 穴径：4.3mm



1



3



5

NEW AXP 5661
-
1,3,5
LE/MB
☞ ☒ 穴径：4.4mm



AXP 5562
37
42
LE/MB
☒ 穴径：4.3mm

〈染色イメージ〉



[23]



[18]

NEW KP 9400
23,18
01
PA
☞ ☒ ☒
穴径：4mm(23mm)
穴径：3mm(18mm)



N



BN



AG

NEW AB 8044N
25
N,BN,AG
MB
☞ ☒ ☒ 穴径：5.9mm



白



PG



AG



PN



N

BP 5924
21
白 G,PG,AG,PN,N
PA ABS
☞ ☒ ☒ 穴径：6mm



01



42



45



48



09

KP 9367
-
01 09,42,45,48
PA PA
☞ ☒ ☒ ☒ 穴径：4mm



new VP 1028
 20
 41,45,47,09
 UP
 ☆ ⊗ 穴径：4mm



new VP 1027
 20
 41,45,47,09
 UP
 ☆ ⊗ 穴径：6.5mm



new VP 1026
 20
 41,42,46,09
 UP
 ☆ ⊗ 穴径：4mm
 ※一つ一つの色・柄が異なります。

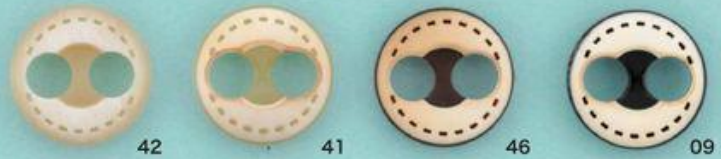

new VP 1025
 20
 41,42,46,09
 UP
 ☆ ⊗ 穴径：6.5mm
 ※一つ一つの色・柄が異なります。

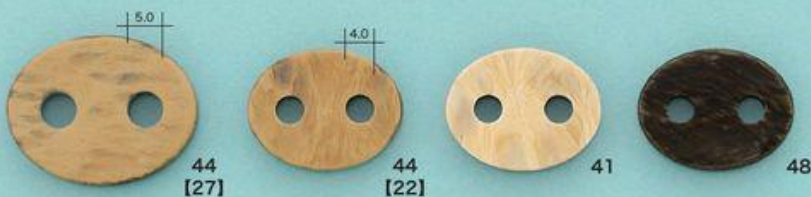

OJM 676V
 27,22
 41,44,48
 UP
 ☆ ⊗



new AXP 5659
-
N,BN,AG
MB
2.5
5.0



new AXP 5656
-
N,BN,AG
MB
3.5
5.5



new AXP 5658
-
N,BN,AG
MB
3.7
4.7



new AB 8015N
20
N,BN,AG
MB/CU
7.9
3.9



new AXP 5657
-
N,BN,AG
MB
3.0
4.5



RG 11
-
G,N,BN,AG
ABS
3.0
4.5



KP 9313N
-
G,N,BN,PN,AG
ABS
2.9
4.3



KP 9311N
-
G,N,BN,PN,AG
ABS
3.0
4.3



AB 6956N
15
G,N,PNW,BN,ASI,AG,BNK
MB/CU
4.5
2.5
实用新案 [3059780]

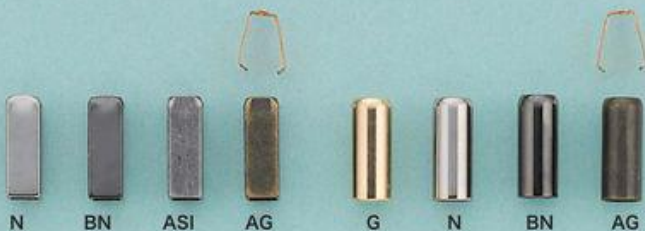

AB 6957N
15
N,BN,ASI,AG
MB/CU
3.9
2.5
实用新案 [3059780]

AB 7073N
15
N,BN,AG
MB/CU
5.0
2.5
实用新案 [3059780]

メタルチップ加工
(検針機対応)



※サイズによって加工が出来ない場合があります。
※金属の為、メッキでの多少のロット違いが発生
する場合があります。



KP 9319N
-
G,N,AG,BN
ABS



KP 9317N
-
G,N,BN,AG
ABS

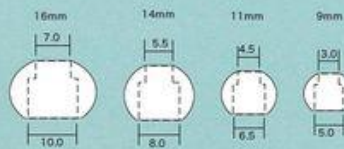

RG 14
16,14,11,9
G,PG,N,PN,BN,AG
ABS

※BN,G,Nは20mmがございます。
※PNは14mm,11mm,9mmの
取扱いサイズになります。



RG 3
-
BN,N,G,PG,PN,AG
ABS



RG 5
-
G,N,PN,PG,BN,AG
ABS



RG 31
-
PG,PN,G,AG,N,BN
ABS



RG 24
-
G,N,PG,PN,AG,BN
ABS

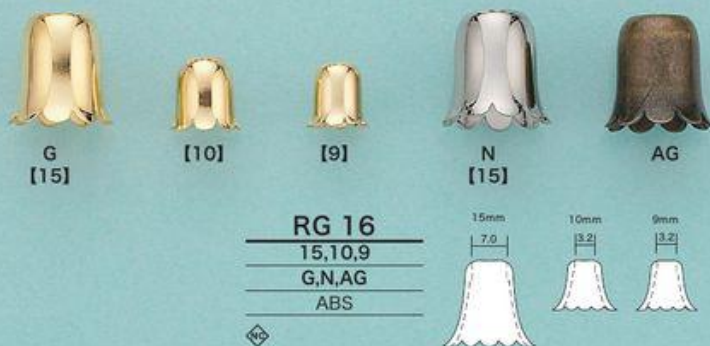
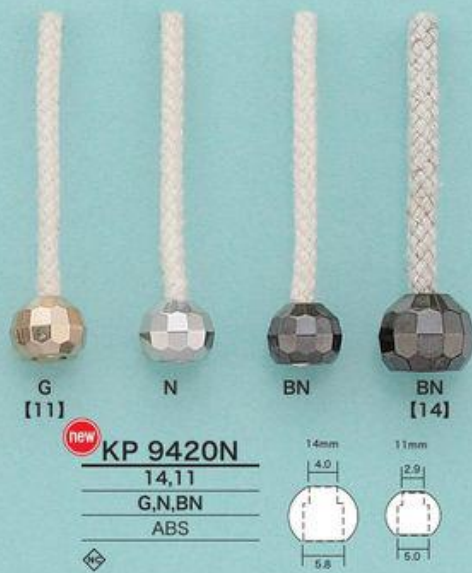



new AB 8194F
15,10,6
AG,BN,G,N
MB
free

*AB8194Fは在庫が無くなり次第、
AB8694Nに型番変更されます。

AB 7297N
10,6
G,N,BN,AG
MB



AB 7701N
G,N,BN,AG
MCD
3

(染色イメージ)



AB 7697N
G,N,BN
EP/MCD
4



廃番
Discontinued

AB 7049N
14
N
MB/SIM
3.0
3.0
実用新案 [3065370]

MK-527 ミックススピンコード
ポリエステル 100% (一反 50m 巻)

●コード (形状・太さ) サンプル



KP 9382N
G,N
RH/ABS
3.0
5.0



KP 9372N
G,N
ABS
4.3
(接着)

●コードカラーサンプル



コードエンド

NEW **KP 9410**

00N,00G 01N,01G
MB/PC MB/PA

☀️ ⚡️ ⚙️ ⚙️ ⚙️ ⚙️ ⚙️ ⚙️

☒ (E)

2.5
4.9

NEW **KP 9411**

00N,00G 01N,01G
MB/PC MB/PA

☀️ ⚡️ ⚙️ ⚙️ ⚙️ ⚙️ ⚙️ ⚙️

☒ (E)

2.5
4.9

NEW **KP 9412**

00N,00G 01N,01G
MB/PC MB/PA

☀️ ⚡️ ⚙️ ⚙️ ⚙️ ⚙️ ⚙️ ⚙️

☒ (E)

3.7
8.0

NEW **KP 9413**

00N,00G 01N,01G
MB/PC MB/PA

☀️ ⚡️ ⚙️ ⚙️ ⚙️ ⚙️ ⚙️ ⚙️

☒ (E)

3.5
8.0

先染めポリエステルコード ポリエステル 100% (50m カセ)

●コード (形状・太さ) サンプル

K-300 16打 細



K-300 16打 中



K-300 16打 太



K-400 ハツ打 細



K-400 ハツ打 中



K-400 ハツ打 太



●コードカラーサンプル

001	009	017	025
002	010	018	026
003	011	019	027
004	012	020	028
005	013	021	029
006	014	022	030
007	015	023	031
008	016	024	

※コードの取扱いの詳細、試験データは、【素材の取扱い上のご注意】をご覧下さい。別注色も開きますのでご用命下さい。
※サンプル (見本) の依頼は、長さ (1m ~ 5m) の範囲で承ります。他、ご不明な点は当社営業員にお問い合わせください。

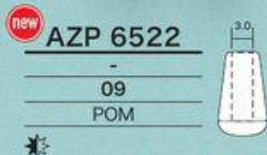

上下のパーツを別々に染める事で、2色使いのカラーバリエーションを演出できます。

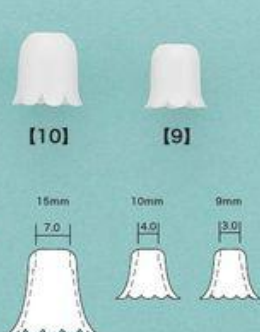
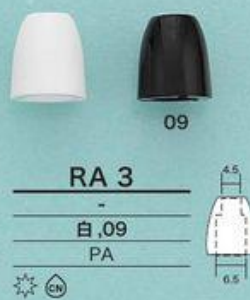
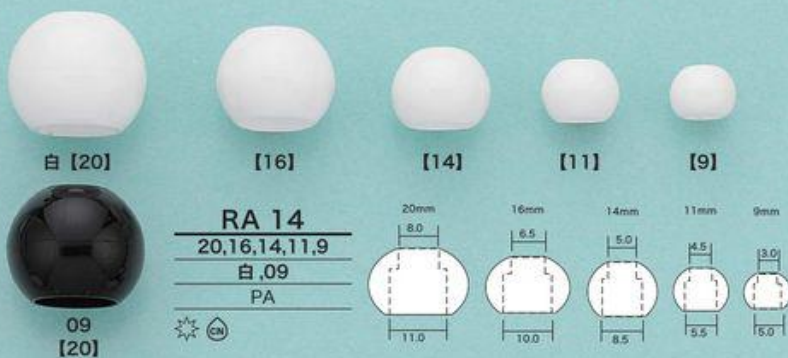

RA 11
 -
 白
 PA

☀️ (CN)

CS 5700
 -
 01
 PA

☀️ (CN)

CL 10
 -
 K,T
 CS

☀️ * (CN)

CL 6200
 10
 000,001
 UP

☀️ (P)



CL 16
 18,15,13,11.5,10,8
 K,T
 CS

☀️ * (CN)



CL 12
 18,16,13
 K,T
 CS

☀️ * (CN)

CL 6013
 18,15,12
 -
 UP

☀️ (P)



CL 123
 15,13,11.5,10
 白
 UP

* (P)

CL 6010
 15,13,11.5
 白
 UP

☀️ (P)



new CL 6203

12
-
UP

☀️ (P)



new CL 6204

12
-
UP

☀️ (P)





白 72

☀️ ☒ (CN)

CL 6201
16
白,72
CS





001 01 72

☀️ (CN)

KP 9312
-
001,01,72
PA



VP 1003

11.5
00
UP

☀️ (P)



VP 1010

-
-
UP

☀️ (P)





001 01 72

☀️ (CN)

KP 9314
-
001,01,72
PA







001 01 72

☀️ (CN)

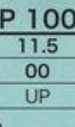
KP 9320
-
001,01,72
PA

VP 1010

-
-
UP

☀️ (P)

VP 1010

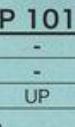
-
-
UP

☀️ (P)





001 01 72

☀️ (CN)

KP 9318
-
001,01,72
PA







02 [14] 02 [9] 02 [11] 08 [11] 05 [11]

CS 2223

14,11,9
02,05,08
PA

☀️ (CN)





00 01 09

☀️ ☒

CS 5602
18
00,01,09
UP





new VP 1024

9
72
UP

☀️ ☒

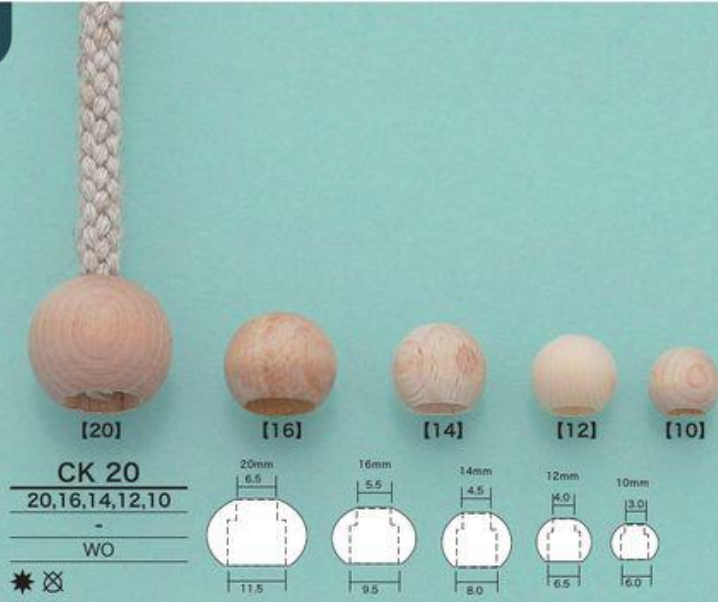



CK 20
20,16,14,12,10
-
WO
* ☒

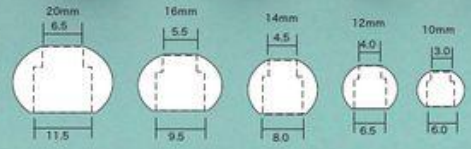

CK 10
18,15,12,10
-
WO(P)
* ☒

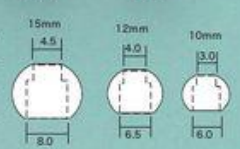

AZP 6335
15
-
WO(P)
* ☒

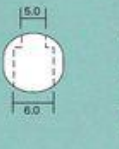

AZP 6334
15
-
WO(P)
* ☒



CK 6
18,15,12
-
WO(P)
* ☒

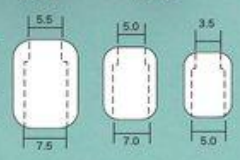

CL 6202
16
-
WO(P)
* ☒



OW 4400
-
-
BA
3
4



グロッシューコード コットン 100% (先染 50m カセ)
●コード (形状・太さ) サンプル

P51 のカラーサンプルよりお選び下さい。

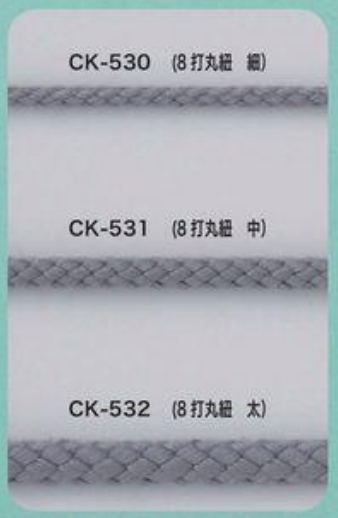
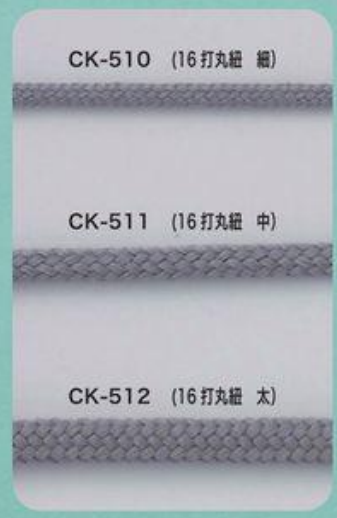

ロットにより多少色目が異なる場合があります。

コードの取扱い ☒ ☒ ☒ ☒ ☒ ※コードの取扱いの詳細、試験データは、[素材の取扱い上のご注意] をご覧下さい。
※サンプル (見本) ご依頼は、長さ (1m ~ 5m) の範囲で承ります。他、ご不明な点は当社営業員にお問い合わせください。

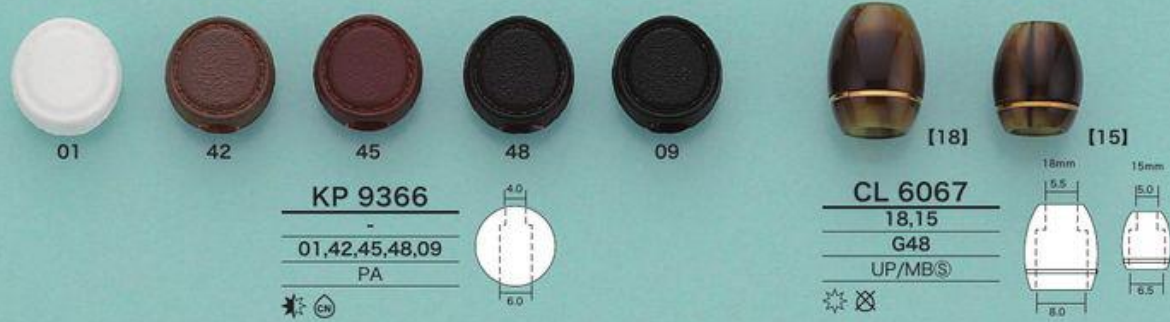

グロッシーコード

●カラーサンプル



ロットにより多少色目が異なる場合があります。



new KP 9405

8
00,09
PU

* ☒



new KP 9406

10
00,09
PU

* ☒



new KP 9407

10
00,09
PU

* ☒



CS 3029

-
00,09
PU

* ☒ ☉ ☋

CS 3028 (PAT.P)

-
00,01,09
PU

* ☒ ☉ ☋



CS 3028の使用イメージ

MK-526 ミックスコード
ポリエステル 100% (一反 50m 巻)

●コード (形状・太さ) サンプル

M
(太さ見本)



L
(太さ見本)



CS 3027 (PAT.P)

-
00,01,09
PU

* ☒ ☉ ☋



●コードカラーサンプル

(カラーNo.)

01



02



03



04



05



06

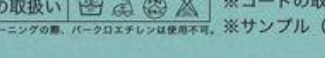

07



08



09



10



11



12

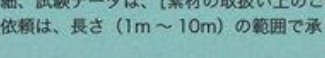

013



014



015



016



017



018

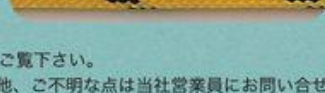

019

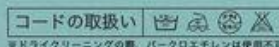
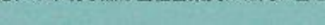

※コードの取扱いの詳細、試験データは、【素材の取扱い上のご注意】をご覧ください。

※サンプル (見本) の依頼は、長さ (1m ~ 10m) の範囲で承ります。他、ご不明な点は当社営業員にお問い合わせください。



new AZP 6492

-
09
PC

★ ⊗ ⊗



new AZP 6493

-
09
PC

★ ⊗ ⊗



CS 3042

-	
00	01,09
PC	PA

★ ⊗ ⊗ ⊗ ⊗ ⊗

コネクティングパーツ



AZP 6490

-
00,09
PC

★ ⊗ ⊗

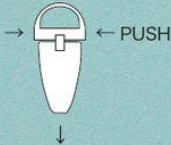

コネクティングパーツ



AZP 6491

-
00,09
PC

★ ⊗ ⊗

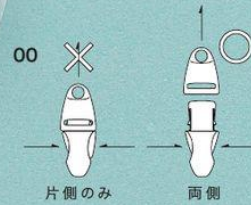

片側だけ押しても外れない安全機構

簡単装着、無縫製タイプ



AZP 6486

-
09
PP

★ ⊗ ⊗

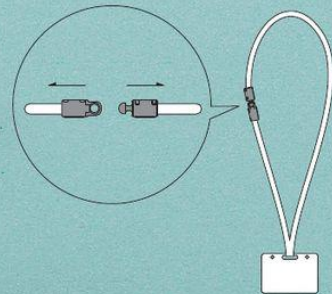

AZP 6485

-
09
PP

★ ⊗ ⊗

丸紐3mm平紐10mm



09
[30]

[25]

[20]

[15]

CS9101,CS9102 の使用方法

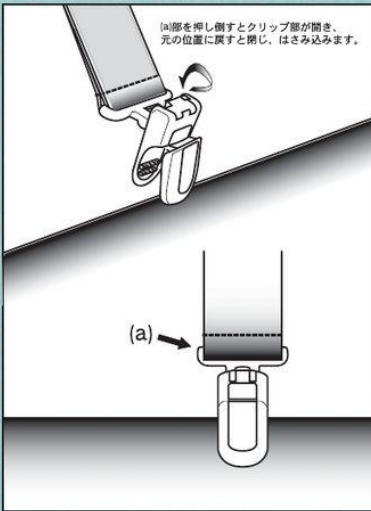

00
[15]

01

CS 9102	
00,01,09	
30,25,20,15	
PC	
☼	☒
☒	☒
☒	☒



09
[30]

[20]

[15]

00
[15]

01

CS 9101	
00,01,09	
30,20,15	
PC	
☼	☒
☒	☒
☒	☒



09
[40]



[30]



[25]



00
[15]



01



09



09
[20]

CS 9103
00,01,09
40,30,25,20,15
PC

☼ ☒ ☒ ☒
※30mm は在庫がなくなり次第、
25,20mm と同形状になります。

【サスペンダー用背クロス】



09
[40]



[30]



[25]



00
[15]



01



09



09
[20]

CS 9104
00,01,09
40,30,25,20,15
PC

☼ ☒ ☒ ☒



01



03



09

AZP 6481

01,03,09

PC/POM



01



03



09

AZP 6483

01,03,09

PC/POM

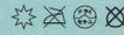

01



03



09

AZP 6482

01,03,09

PC/POM



01



03



09

AZP 6484

01,03,09

PC/POM



〈CS 9108 使用イメージ〉

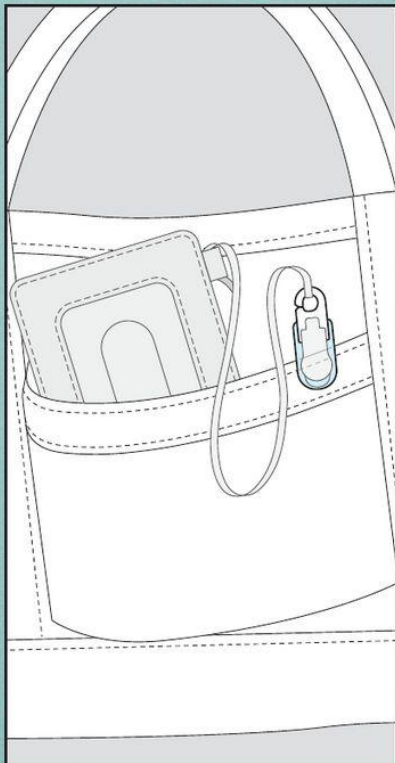

00



06



09

AZP 6452

00,06,09

PC/POM



CS 9108

00

PC



CS 9107

00

PC

